

Brief Description of KR 2 controller



Page 2 **1. Safety and warning information**

Page 6 **2. Intended use of devices**

Page 7 **3. Functions of the controller**

Page 13 **4. Technical data**

Page 14 **5. Terminal layout diagram**

Page 15 **6. Connections and commissioning**

Page 17 **7. Faults and fault finding**

1. Safety and warning information

Before installing or commissioning the frequency inverter, please read this operating manual carefully and observe all safety and warning notices. Keep this operating manual close to the frequency inverter in a place that is accessible at all times.

Risk levels:



DANGER

Imminent danger that could result in serious bodily injury or death.



WARNING

A potentially hazardous situation that could result in serious bodily injury or death.



CAUTION

A potentially hazardous situation that could result in minor injury.



ATTENTION

A potentially hazardous situation that could result in material damage.

General:

During operation it must be ensured that the mains supply is present at all times.



WARNING

- The KR2 controller generates hazardous electrical voltages and controls hazardous rotating machinery. Failure to observe the information contained in this handbook can result in death, severe bodily injury or significant material damage.
- The installation, commissioning and maintenance of these drive units may only be performed by competent personnel who are wholly familiar with the functioning of this equipment and of the entire machine.
- Competent personnel are persons who, thanks to their technical training, knowledge and experience and their knowledge of the applicable statutory provisions, are capable of assessing the work assigned to them and recognising potential hazards.
- Frequency inverters and mains filters both contain capacitors that can maintain high voltages even after the mains supply has been switched off. You should therefore wait at least 10 minutes after switching off the supply before opening the unit and working on it. Check voltages before commencing work with an appropriate measuring instrument. Take care not to touch any live parts.
- Ground (earth) the KR2 controller at the terminals provided and check that the leakage current does not exceed 3.5 mA. The minimum cross-sectional area of the earthing conductor must meet the local safety regulations for equipment with high leakage currents.
- To prevent injury and damage, do not touch any parts within the housing – either with the hands or with any other object – when the supply voltage is present or the intermediate circuit capacitors are not discharged.



WARNING

- Do not work on the wiring while the mains voltage is present. The inverter must not be connected to the mains supply while the housing is open and components can be touched.
 - Take particular care if the automatic restart function is activated. To prevent injury from a potentially uncontrolled restarting of the frequency inverter following a loss of power, install a switch element on the mains side that opens the circuit in the event of a power outage and that requires manual resetting once power is restored (e.g. a contactor etc.)
 - Ensure that the supply voltage corresponds to the voltage specified on the rating plate. Environmental influences such as high temperatures and high humidity should be avoided, and likewise dust, dirt and aggressive gases. The installation position should be well ventilated and not subject to direct sunlight.
 - Install the unit on a non-inflammable, vertical wall that does not transmit vibrations.
- Caution!** Do not connect mains voltages to the output terminals U/T1, V/T2 or W/T3.
- If standard motors are to be driven with frequencies >60 Hz, please first contact the motor or machine manufacturer.
 - All controllers have been tested for dielectric strength and insulation resistance. Insulation resistance measurements, e.g. during inspections, may only be performed between the power terminals and earth. Do not perform any insulation resistance measurements on the control terminals.
 - Issue the START/STOP operating signals via the control terminals or the control panel and not by switching the mains or motor contactor on or off. Do not install any capacitance or overvoltage arrestors on the motor supply lines.

ATTENTION

- To ensure that your KR2 controller functions safely and reliably, all applicable safety regulations, e.g. accident prevention regulations, the workplace guidelines of professional associations, VDE regulations, etc. must be observed. Since these provisions are treated differently in different parts of the German-speaking world, the user must observe the version relevant to his location. Klingenburg GmbH cannot release the user from the obligation of observing the latest safety regulations in every case.
- The technical data and descriptions in this operating manual have been prepared to the best of our knowledge and belief. Improvements are however being constantly made to products, and Klingenburg GmbH therefore reserves the right to make any such changes without prior announcement.
- On receipt of the unit, check that no transport damage is present. Check that the goods supplied (as specified on the rating plate) correspond to the goods listed on the delivery note and to your order.
- This manual has been prepared with the utmost care and attention. Klingenburg GmbH can nevertheless not be held liable for any faults or damages that may arise from the use of this manual.

ENVIRONMENT AND DISPOSAL

- Help to protect the environment by disposing of packaging and end-of-life products in an environmentally sustainable manner. Products with this labelling may not be disposed of in ordinary household waste; they must be disposed of separately in accordance with local regulations.



→ CE EMC INSTALLATION

- The KR2 series of controllers are not for household use but are intended solely to be used as components for further use in an industrial context. They are electrical devices for controlling speed-regulated drives based on three-phase motors and are designed to be fitted into machines or combined with other components of a machine.
- In a residential environment, particularly if the motor supply cables are >15 m in length, Klingenburg KR2 controllers may cause high-frequency interference that would require additional interference suppression measures.

2. Intended use

- The KR2 series of controllers are not for household use but are intended solely to be used as components for further use in an industrial context. They are electrical devices for controlling speed-regulated drives based on three-phase motors and are designed to be fitted into machines or combined with other components of a machine.



REASONABLY FORESEEABLE MISUSE

To minimise the risk of misuse that can be reasonably foreseen, use of this electrical equipment is restricted to the following environmental conditions:

- For operation only by instructed persons and specialists in an industrial setting
- For use only in a non-explosive atmosphere (no Ex zones)
- Must be protected from weather
- Temperature range (ambient): -10°C to +35°C
- Air humidity (ambient): 20-90% (relative), non-condensing
- For commercial use in ventilation systems only.
- Avoid exposure to direct sunlight
- Install in an well-ventilated place. Allow 100 mm clearance above and below unit
- IP protection class(es) for electrical equipment against ingress of solid foreign bodies or liquids: IP 54
- Material properties: aluminium

3. Functions of the controller

- Regenerative heat recovery rotors can be controlled in power terms by means of the rotation speed of the storage mass. KR controllers allow the speed of the rotor to be controlled throughout the speed range by means of an analogue control signal.
- The KR2 can provide control by means of an 0-10 V / 4-20 mA signal. It is therefore suitable both for integration in a conventional automatic ventilation system and for modern solutions.

- The rotary heat exchanger motors are protected against overheating by a thermostat. The mechanical functioning of the rotor can be monitored using an optional run check feature. Here a magnetic sensor monitors the rotation of the rotor storage mass when there is a demand for heat recovery.
- The KR2 controller is designed for installation as a compact, easy-to-use controller for small heat recovery systems (protection class IP 54). It allows control of three-phase motors with a power of up to 180 watts.

➔ SPECIAL FEATURES

- The design of the controller has taken into account all regulations known to us
- Once wired in, the controller is ready for use as soon as you switch on
- Short circuit-proof output (24 V)
- Each individual controller is tested
- Thermal contact monitoring
- Self-cleaning function
- Protection class: IP 54
- Optionally available with a bus interface (RS 485)
- Optional accessory: rotor run check (see page 29)

➔ OPTIONAL ACCESSORY: ROTOR RUN CHECK



Rotor run check in rotor housing

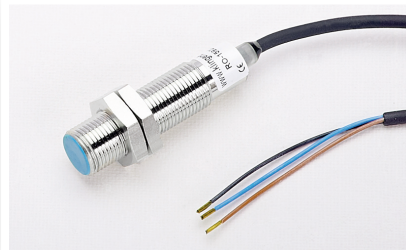

Klingenburg run check sensor

| | |
|-----------------------------|---|
| Manufacturer | Klingenburg |
| Type | MMG 120BDKX, PNP magnetic switch |
| Protection class | IP67 |
| Supply voltage | 10-30 V= |
| Contact | Magnet |
| Switching gap | <=30 mm |
| Colours of connecting wires | blue / brown / black |
| Application | Rotors, sorption wheels, stroke sensor cleaning |

→ INSTALLATION DETAILS

When fitting the housing, the following must be observed:

- The housing must always be secured at all four fixing points
- Sufficient ventilation must be available at all times
- The controller must always be easily accessible
- The controller must be protected from environmental influences (UV radiation, rain, frost)

→ FITTING THE CONTROLLER HOUSING

The housing has four holes ○ (Ø 6.5 mm) for fixing to the installation site. When fitting the housing, the following must be observed:

- Shielded cables must always be used for the motor and thermostat connections. Cable lengths must not exceed 15 m.
- The ferrite core supplied with the unit must be fitted above the supply cable inside the controller.

→ OPENING AND CLOSING THE CONTROLLER HOUSING

The housing is opened by means of four bolts **A**.

A Torx TX 10 screwdriver is required for opening the housing.

The maximum tightening torque for the bolts is 0.4 Nm.

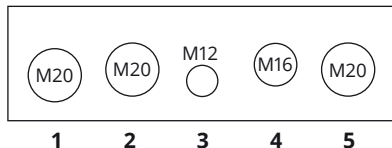
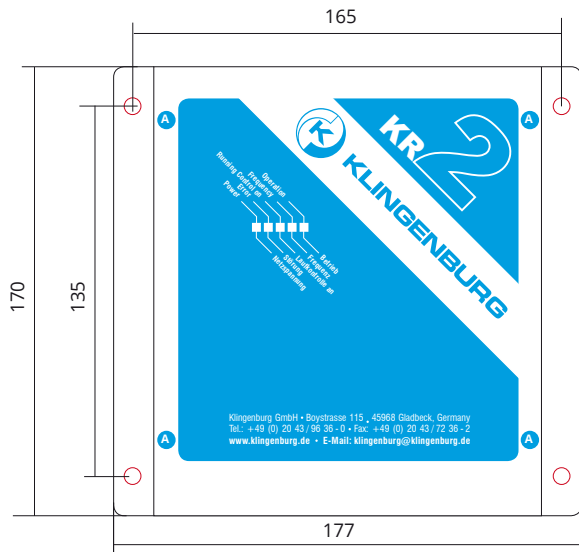

■ As supplied, the M12 cable gland (for rotor run check) is locked. If the controller is to be used with a run check, the dummy plugs must be removed.

- 1) Control cable
- 2) Supply cable 3 x 1,5 mm²
- 3) Rotor run check (optional accessory MMG 120)
- 4) Thermostat (Motor 2 x 0,75 mm² shielded cable)
- 5) Three-phase motor (4 x 0,75 mm², shielded cable)

CAUTION

The ferrite core supplied must be used for the supply cable (230 V) as shown here.

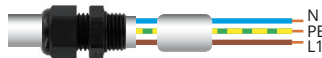

→ DIP SWITCH SETTINGS

1. Reset: Each change in the switch settings causes a reset of the controller, irrespective of the position of the switch.

2. Offset: To supply the KR2 with 4-20 mA the offset must be set to ON, so that the wheel can be stopped at 4 mA.

3. Fmax: Two maximum frequencies (Hz) can be set on the controller

Switch ON: 120Hz **Switch OFF:** 80Hz.

4. Rotor run check on: If a run check element is connected, it must be activated by means of this switch.

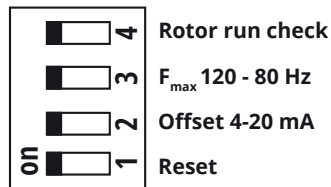

→ OPERATING STATUS LEDs

| | |
|-----|--------------------|
| LED | ● Operation |
| | ● Run check pulse |
| | ● Run check active |
| | ● Fault |
| | ● Power |

Indicates that the wheel is rotating

Flashes briefly when a pulse is received from run check

Indicates that run check is activated

Indicates that a fault has occurred

Indicates that supply power is present

4. Technical data

| | |
|------------------------------|---|
| Power rating | 180 W |
| Fuse (internal) | 6.3 A slow-blow (5 x 20 mm) |
| Mains voltage | 190-240 Volt / 50-60 Hz 1~ |
| Weight | 1200 g |
| Ambient temperature | from -10°C to +35°C (at temperatures below 0°C mains power should first be applied to the unit without the motor running to enable the controller to warm up before use) |
| Protection class | IP 54 |
| Output frequency | 0-120 Hz (factory setting 80 Hz) |
| Control signals | 0-10 V, 0-20 mA, 4-20 mA |
| Fault message relay | Potential-free changeover contact, rating 250 V AC, 1 A |
| Motor connector cable | The connecting cable must be shielded under all circumstances. Where lengths are greater than 20 m, chokes must be fitted. Contact us. |
| Dimensions | L170 mm W=180 mm H=90 mm |

5. KR2 terminal layout diagram

Jumper position
0-20 mA, 4-20mA



Jumper position
0-10 V DC



Fuse
6.3 A
slow-blow

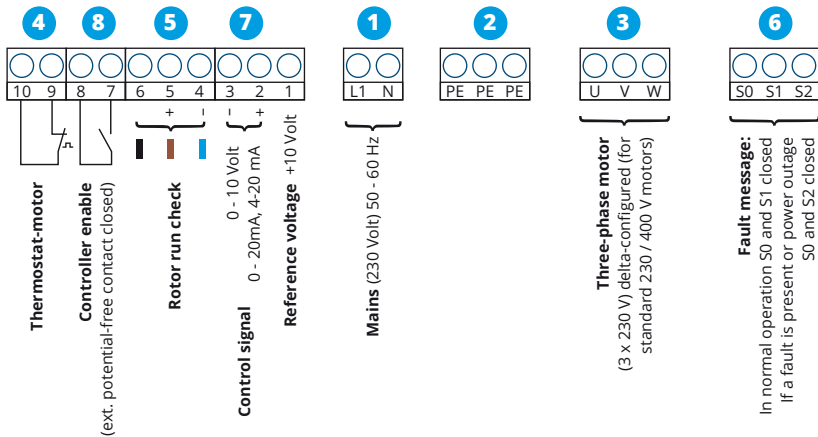

6. Connections and commissioning

→ CONNECTIONS

1 Power input

The KR2/bus controller are connected to the mains supply at 230 V AC, 50 Hz.

2 Protective Earth conductor

The protective earth conductor must be connected at all times.

3 Connections to motors

To avoid interference effects from motor supply lines, these must be laid individually in shielded cables. The controller has a motor output voltage of 3 x 230 V. This must be noted when wiring the motor terminal block. Motor rotation: clockwise UVW, anticlockwise WVU.

4 Motor thermostat

Failure to connect the motor thermostat will void the warranty of the motor and also result in a fault in the controller.

5 Rotor run check (optional)

Connect the optional run check sensor (MMG 120) to terminals four, five and six. Please note that the run check sensor must be activated during commissioning of the controller.

6 Fault message contact

In normal operation S0 and S1 closed. If a fault is present or power outage, S0 and S2 closed

7 Control signal

For a control signal in the 0-20 mA range the jumper must be positioned as shown on page 14. For a control signal in the range 4-20 mA, DIP switch 2 (offset) must be enabled

8 Controller enable

Controller enable is controlled via terminals 7 and 8 of the controller terminal block. The contact to which the controller enable is connected must be potential-free

→ COMMISSIONING

The controller may only be switched on once installation is complete and all the requirements of the relevant EU directives are observed. If the product has been installed in accordance with these installation instructions and with the applicable installation regulations, it will be covered by the manufacturer's warranty.

- Before commissioning the controller, check that the rotor can rotate freely. The rotor must not be allowed to become blocked.
- Check all terminals/cables within the controller and on the motor to ensure that they are secure and correctly positioned.

- Once all connections have been made and the DIP switches have been set to suit the device type, the supply power can be switched on.
- Close the enabler contacts (nos. 7 and 8). Now the KR2 is ready for operation. As supplied, the controller is designed for signal within the set value range 0-10 V DC. For 0 – 20 mA or 4 – 20 mA (external signal) a jumper must be repositioned. This jumper is situated behind the terminal strip for inputs 1 to 10. Now the rotor can be activated by applying an analogue control signal (0-10 V or 0-20 mA/4-20 mA) and the speed varied.

The 0-10 V set value signal must be absolutely DC. The 10 V level must not be exceeded as this may irreparably damage the controller.



7. Faults and fault finding

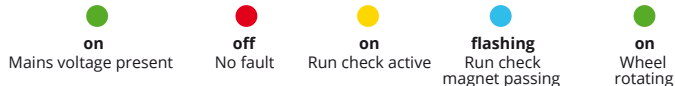

→ LED STATUS INDICATOR

A LED display indicates the status of the KR2; e.g. for normal operation



If the LED indications are as shown in the example above following commissioning, the commissioning has been successfully completed. Following commissioning the motor current should be measured at maximum rotating speed using a clamp ammeter and compared with the nominal current rating on the motor rating plate.

| LEDs | Fault | Cause | Remedy |
|---|---|---|--|
|  | Controller does not function | No power supply to controller | Check mains voltage and microfuse |
| | | Controller terminals short-circuited | Disconnect all conductors from controller (except L1/N/PE) |
|  | Power/mains LED lit but controller does not function? | Controller has no enable (terminals 7/8) or control signal absent (Terminals 2 and 3) | Terminals 7/8 must be closed Positive and earth wrong way round. Measure control signal |
| | | | |
|  | Run check fault | Drive belt torn? | Reconnect drive belt (see rotor installation instructions) |
| | | No tension in drive belt? | Retension belt (see rotor installation instructions) |
| | | Rotor rubbing or mechanically jammed | Check storage mass; if necessary realign storage mass |
| | | | Check bearings (see installation instructions) |
| | | Gap of proximity switch is too large | Readjust proximity switch |
| | | No magnet on the storage mass | Retrofit magnet or proximity switch |
| DIP switch is in run check active position but no proximity switch connected | If the run check of DIP switch 4 is set to OFF | | |

| LEDs | Fault | Cause | Remedy |
|---|--|---|--|
|  | Motor overtemperature | Motor has overheated | Check storage mass; it is rubbing or dirty Motor or rotor has a damaged bearing |
| | | Motor is wired in star mode | Motor must be wired 3 x 230 V delta |
| | | Motor thermostat is defective | Motor thermostat is defective Replace motor |
| | | Controller has a short circuit on terminals 5/7/9 +24V 4 - 0 V | Disconnect all conductors from the controller, then re-connect them one by one and note where the fault lies |
| | | Run check has a short circuit | Replace run check element |
| | |  | Hardware error |
| Motor is jammed or overloaded | Check/replace motor | | |
| Overtemperature in output stage of inverter | Controller ambient temperature is too high | | |
| Communication fault in controller | Perform reset on controller and retest | | |



Klingenburg GmbH
Boystraße 115
45968 Gladbeck
Germany

Tel.: +49-20 43-96 36-0
Fax: +49-20 43-7 23 62
E-mail: info@klingenburg.de
www.klingenburg.de